



INSTRUCTION MANUAL

VHF TRANSCEIVERS

IC-F3022T/S

UHF TRANSCEIVERS

IC-F4022T/S

Icom Inc.



The photo shows the 10-key version VHF transceiver.

IMPORTANT

READ ALL INSTRUCTIONS carefully and completely before using the transceiver.

SAVE THIS INSTRUCTION MANUAL — This instruction manual contains important operating instructions for the **IC-F3022T/S VHF TRANSCEIVERS** and the **IC-F4022T/S UHF TRANSCEIVERS**.

EXPLICIT DEFINITIONS

WORD	DEFINITION
⚠ WARNING	Personal injury, fire hazard or electric shock may occur.
CAUTION	Equipment damage may occur.
NOTE	If disregarded, inconvenience only. No risk of personal injury, fire or electric shock.

Icom, Icom Inc. and the  ICOM logo are registered trademarks of Icom Incorporated (Japan) in the United States, the United Kingdom, Germany, France, Spain, Russia and/or other countries.

PRECAUTIONS

⚠ CAUTION! NEVER hold the transceiver so that the antenna is very close to, or touching exposed parts of the body, especially the face or eyes, while transmitting. The transceiver will perform best if the microphone is 5 to 10 cm away from the lips and the transceiver is vertical.

⚠ CAUTION! NEVER operate the transceiver with a headset or other audio accessories at high volume levels.

⚠ CAUTION! NEVER short the terminals of the battery pack.

⚠ CAUTION! NEVER use non-Icom battery packs/chargers to prevent the loss of the transceiver's good performance and warranty.

DO NOT push [PTT] when not actually desiring to transmit.

DO NOT use or place the transceiver in direct sunlight or in areas with temperatures below -25°C or above $+55^{\circ}\text{C}$.

The basic operations, transmission and reception of the transceiver are guaranteed within the specified operating temperature range. However, the LCD display may not be operate correctly, or show an indication in the case of long hours of operation, or after being placed in extremely cold areas.

DO NOT modify the transceiver for any reason.

KEEP the transceiver away from the heavy rain, and Never immerse it in the water. The transceiver meets IP54* requirements for dust-protection and splash resistance.

However, once the transceiver has been dropped, dust-protection and splash resistance cannot be guaranteed due to the fact that the transceiver may be cracked, or the water-proof seal damaged, etc.

* Only when the supplied battery pack, flexible antenna and jack cover are attached.

Icom optional equipment is designed for optimal performance when used with this transceiver. We are not responsible for the transceiver being damaged or any accident caused when using non-Icom optional equipment.

TABLE OF CONTENTS

IMPORTANT	i	4 BATTERY CHARGING	16–20
EXPLICIT DEFINITIONS	i	■ Caution	16
PRECAUTIONS	i	■ Optional battery chargers	18
TABLE OF CONTENTS	iii	5 BATTERY CASE	21
1 ACCESSORIES	1–3	■ Optional battery case (BP-240)	21
■ Supplied accessories	1	6 OPTIONAL SWIVEL BELT CLIP	22–23
■ Accessory attachments	1	■ MB-93 contents	22
2 PANEL DESCRIPTION	4–8	■ Attaching	22
■ Front panel	4	■ Detaching	23
■ Function display	5	7 OPTIONS	24–25
■ Programmable function keys	6	8 DOC	26
3 BASIC OPERATION	9–15		
■ Turning power ON	9		
■ Channel selection	10		
■ Call procedure	10		
■ Receiving and transmitting	11		
■ User set mode	13		
■ Stun function	13		
■ Emergency Call	14		
■ Man Down Emergency Call	14		
■ Scrambler function	14		
■ Priority A channel selection	14		
■ MDC 1200 system operation	15		

■ Supplied accessories

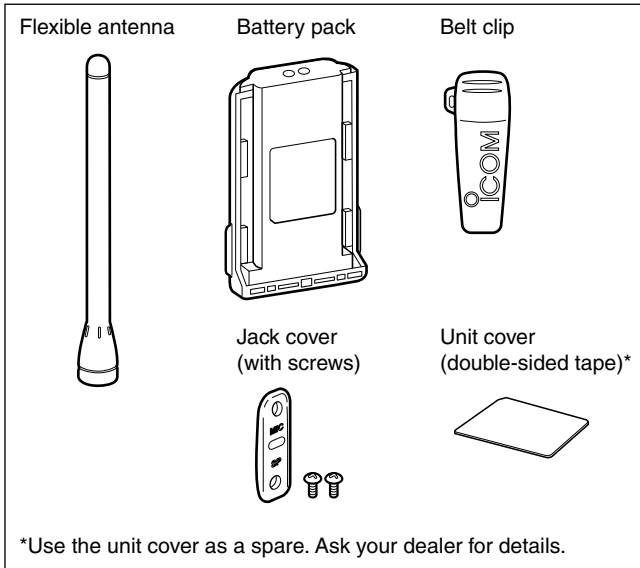

■ Accessory attachments

◇ Flexible antenna

Connect the supplied flexible antenna to the antenna connector.

CAUTION!

- **NEVER HOLD** the antenna when carrying the transceiver.
- Transmitting without an antenna may damage the transceiver.



1 ACCESSORIES

◇ Battery pack

To attach the battery pack:

Slide the battery pack in the direction of the arrow (❶), then lock it with the battery release button.

- Slide the battery pack until the battery release button makes a 'click' sound.

To release the battery pack:

Slide the battery release button in the direction of the arrow (❷) as shown below. The battery pack is then released.

NEVER release or attach the battery pack when the transceiver is wet or soiled. This may result water or dust getting into the transceiver/battery pack and may result in the transceiver being damaged.

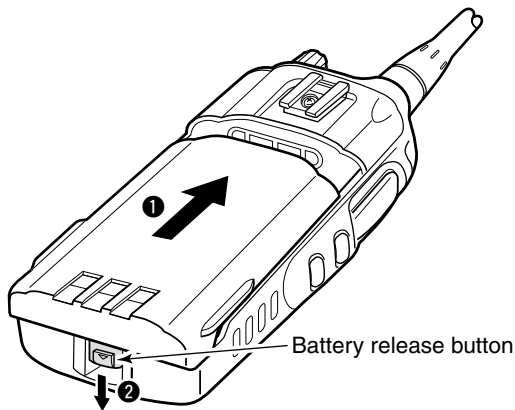

◇ Belt clip

To attach the belt clip:

- ❶ Release the battery pack if it is attached.
- ❷ Slide the belt clip in the direction of the arrow until the belt clip is locked and makes a 'click' sound.

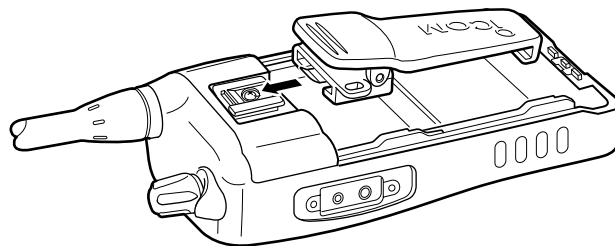

To detach the belt clip:

- ❶ Release the battery pack if it is attached.
- ❷ Pinch the clip (❶), and slide the belt clip in the direction of the arrow (❷).

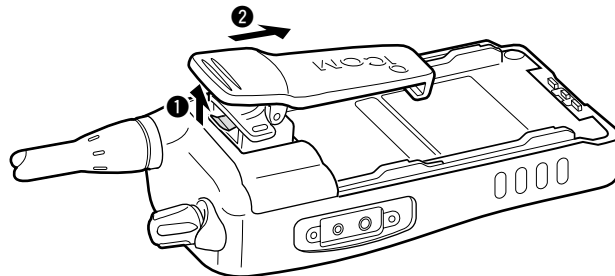

◇ Jack cover

Attach the jack cover when the optional speaker-microphone or headset is not used.

To attach the jack cover:

- 1 Attach the jack cover to the [MIC/SP] jack.
- 2 Tighten the screws.

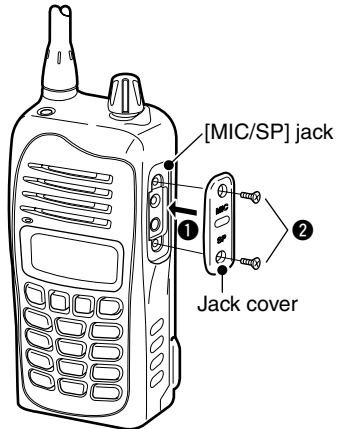

To detach the jack cover:

- 1 Unscrew the screws using a phillips screwdriver.
- 2 Detach the jack cover for the speaker-microphone or headset connection.

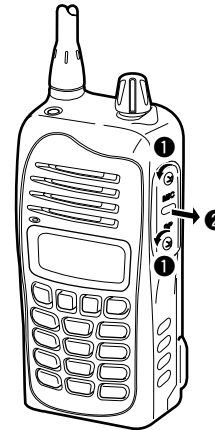

CAUTION!

- Attach the jack cover when the optional speaker-microphone or headset is not used.
- Use the supplied screws only.

■ Front panel

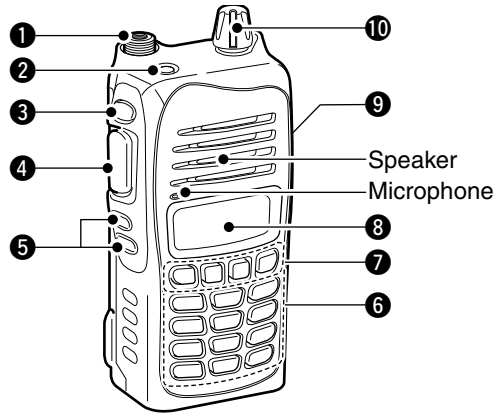

1 ANTENNA CONNECTOR

Connects the supplied antenna.

2 DEALER-PROGRAMMABLE KEY [Emer]

Desired function can be programmed by your dealer. (p. 6)

3 DEALER-PROGRAMMABLE KEY [Side1]

Desired function can be programmed by your dealer. (p. 6)

4 PTT SWITCH [PTT]

Push and hold to transmit; release to receive.

5 DEALER-PROGRAMMABLE KEYS [Side2]/[Side3]

Desired functions can be programmed independently by your dealer. (p. 6)

6 10-KEYPAD (Depending on version)

The keypad allows you to enter digits to:

- Select memory channels
- Select tone channels
- Select DTMF codes (during transmit)
- Set TX codes
- Start up with the password

7 DEALER-PROGRAMMABLE KEYS [P0] to [P3]

Desired functions can be programmed independently by your dealer. (p. 6)

8 FUNCTION DISPLAY (p. 5)

Displays a variety of information such as an operating channel number/name, 5-tone code, DTMF numbers, selected function, etc.

9 EXTERNAL MICROPHONE/SPEAKER JACK

Connect an optional speaker-microphone or headset.

NOTE: Connect or disconnect the optional equipment after the transceiver is turned OFF.

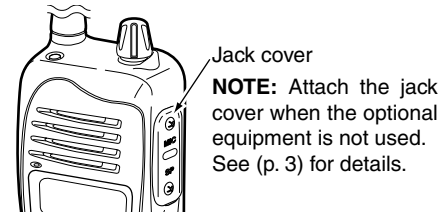

10 VOLUME CONTROL [VOL]

Rotate to turn the power ON/OFF and adjusts the audio level.

■ Function display

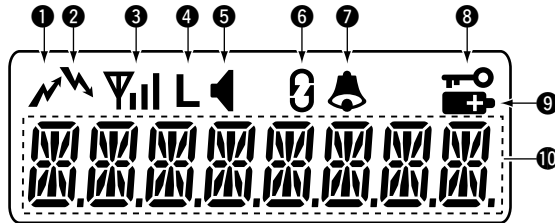

1 TRANSMIT INDICATOR

Appears while transmitting.

2 BUSY INDICATOR

Appears while the channel is busy.

3 SIGNAL STRENGTH INDICATOR

Indicates relative signal strength level.

4 LOW POWER INDICATOR

Appears when low output power is selected.

- When the battery power decreases to a specified level, low power is selected automatically.

5 AUDIBLE INDICATOR

- Appears when the channel is in the 'audible' (unmute) condition.
- Appears when the specified 5-tone code is received.

6 SCRAMBLER INDICATOR

Appears when the voice scrambler function is activated.

7 BELL INDICATOR

Appears/blinks when the specific 5-tone code is received, according to the pre-programming.

8 KEY LOCK INDICATOR

Appears during the key lock function is ON.

9 BATTERY INDICATOR

Appears or blinks when the battery power decreases to a specified level.

10 ALPHANUMERIC DISPLAY

Displays an operating channel number, channel name, Set mode contents, DTMF code, etc.

2 PANEL DESCRIPTION

■ Programmable function keys

The following functions can be assigned to **[Emer]**, **[Side1]**, **[Side2]**, **[Side3]**, **[P0]**, **[P1]**, **[P2]** and **[P3]** programmable function keys.

Consult your Icom dealer or system operator for details concerning your transceivers programming.

If the programmable function names are bracketed in the following explanations, the specific key is used to activate the function depends on the programming.

CH UP AND DOWN KEYS

- ➔ Push to select an operating channel.
- ➔ Push to select a transmit code channel after pushing [TX Code CH Select]. (p. 12)
- ➔ Push to set a transmit code digit after pushing [TX Code CH Select] or [TX Code CH Enter]. (pgs. 12, 13)
- ➔ Push to select a DTMF channel after pushing [DTMF Audiodial].
- ➔ Push to select a scan group after pushing and holding [Scan A Start/Stop]/[Scan B Start/Stop] for 1 sec.

ZONE KEY

Push this key, then push [CH Up] or [CH Down] to select the desired zone.

 **What is “zone”?**— The desired channels are assigned into a zone according to the intended use for grouping. For example, ‘Staff A’ and ‘Staff B’ are assigned into a “Business” zone, and ‘John’ and ‘Cindy’ are assigned into a “Private” zone.

SCAN A KEY

- ➔ This key’s operation depends on the Power ON Scan setting.

When the power ON scan function is turned OFF;

Push to start and cancel scanning operation. In case of transmission during scan, scanning will be cancelled.

When the power ON scan function is turned ON;

Push to pause scanning, then resumes scanning after passing a specified time period. In case of transmission during scan, scanning will be cancelled.

- ➔ Push and hold this key for 1 sec. to indicate the scan group, then push [CH Up] or [CH Down] to select the desired group.

SCAN B KEY

- ➔ Push to start and cancel scanning operation. In case of transmission during scan, scanning will be paused. Then resumes scanning after passing a specified time period.
- ➔ Push and hold this key for 1 sec. to indicate the scan group, then push [CH Up] or [CH Down] to select the desired group.

SCAN ADD/DEL (TAG) KEY

Push to add or delete the selected channel to/from the scan group.

MR-CH 1/2/3/4 KEYS

Push to select memory channels 1 to 4 in the operating zone directly.

WIDE/NARROW KEY

Push to toggle the IF bandwidth between wide and narrow.

PRIO A/B KEYS

- Push to select Priority A or Priority B channel.
- Push and hold [Prio A (Rewrite)] or [Prio B (Rewrite)] for 1 sec. to reassign the operating channel to Priority A or Priority B channel.

MONI KEY

Mute and release the CTCSS (DTCS) or 5-tone squelch mute. Open any squelch/deactivate any mute while pushing this key.

LOCK KEY

- Push and hold for 1 sec. to electronically lock all programmable keys except the following:
[Call] (incl. Call A and Call B), [Moni] and [Emergency].
- Push and hold for 1 sec. again to turn the lock function OFF.

HIGH/LOW KEY

Push to select the transmit output power temporarily or permanently, depending on the pre-setting.

- Ask your dealer for the output power level for each selection.

C.TONE CH ENT KEY

Push to select the continuous tone channel using [CH Up]/[CH Down] to change the tone frequency/code setting. The selected channel remains set as the continuous tone channel until another channel is designated as such.

TALK AROUND KEY

Push to turn the talk around function ON and OFF.

- The talk around function equalizes the transmit frequency to the receive frequency for transceiver-to-transceiver communication.

DTMF AUTODIAL KEY

- Push to enter the DTMF channel selection mode. Then select the desired DTMF channel using [CH Up]/[CH Down].
- After selecting the desired DTMF channel, push this key to transmit the DTMF code.

RE-DIAL KEY

Push to transmit the last-transmitted DTMF code.

CALL KEYS

Push to transmit a 5-tone.

- Call transmission is necessary before you call another station depending on your signaling system.
- [Call A] and/or [Call B] may be available when your system employs selective 'Individual/Group' calls. Ask your dealer which call is assigned to each key.

EMERGENCY KEY

Push and hold to transmit the emergency call.

- The transceiver can transmit the emergency call silently or audibly depending on the pre-setting. Ask your dealer for details.
- When the emergency call transmits with beeps, the emergency text is displayed on the LCD if programmed.
- If you want to cancel the emergency call, push (or push and hold) the key again before transmitting the call.
- The emergency call is transmitted one time only or repeatedly until receiving a control code, depending on the pre-setting.

SURVEILLANCE KEY

Push to turn the surveillance function ON or OFF.

When this function is turned ON, the beep is not emitted and the LCD backlight does not light when a signal is received or a key is pushed, etc.

2 PANEL DESCRIPTION

SIREN KEY

Push to emit a siren.

TX CODE ENTER KEY

Push to enter the ID code edit mode directly, for 5-tone. Then set the desired digit using [CH Up]/[CH Down] or 10-keypad*. (p. 13)
*10-key versions only

TX CODE CHANNEL SELECT KEY

- Push to enter the ID code channel selection mode directly. Then set the desired channel using [CH Up]/[CH Down]. (p. 12)
- During ID code channel selection mode, push and hold for 1 sec. to enter the ID code edit mode for 5-tone code. Then set the desired digit using [CH Up]/[CH Down] or 10-keypad*. (p. 12)
*10-key versions only

TX CODE CHANNEL UP/DOWN KEYS

Push to select a TX code channel directly.

ID-MR SELECT KEYS

- Recalls detected ID codes.
 - Push this key, then select the ID code using [CH Up]/[CH Down].
 - Up to 5 ID's are memorized.
- Push and hold for 1 sec. to erase the selected ID's.

LONE WORKER KEY

Push to turn the Lone Worker function ON or OFF.

- If the Lone Worker function is activated, the Emergency function is automatically turned ON after the specified time period has passed with no operation is performed.

SCRAMBLER FUNCTION

Push to toggle the voice scrambler function ON and OFF.

USER SET MODE KEY

- Push and hold for 1 sec. to enter user set mode.
 - During user set mode, push this key to select an item, and change the value or condition using [CH Up]/[CH Down].
- Push and hold this key for 1 sec. again to exit user set mode.

User set mode is also available via the 'Power ON function.' Refer to (p. 13) also.

OPT OUT KEYS

Push to control the output signal level of the optional ports in the optional unit connector.

OPT MOMENTARY KEYS

Controls the output signal level of the optional ports in the optional unit connector while pushing and holding this key.

Turning power ON

⚡ Prior to using the transceiver for the first time, the battery pack must be fully charged for optimum life and operation. (p. 18)

- ① Rotate [VOL] to turn the power ON.
- ② If the transceiver is programmed for a start up password, input the digit codes as directed by your dealer.
 - 10-keypad can be used for password input depending on version:
 - The keys in the table below can be used for password input:
 - The transceiver detects numbers in the same block as identical. Therefore “01234” and “56789” are the same.

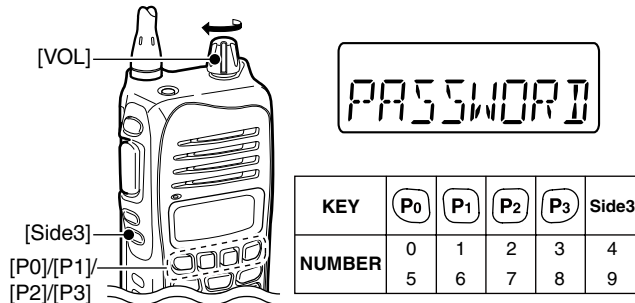

- ③ When the “PASSWORD” indication does not clear after inputting 4 digits, the input code number may be incorrect. Turn the power off and start over in this case.

Battery type selection

The battery type must be selected according to the attaching battery type when turning the transceiver ON. Ask your dealer for details.

- ① Turn the power OFF.
- ② While pushing and holding [Emer] and [PTT], turn the power ON with rotating [VOL] to toggle the attaching battery type.
 - After the display appears, release [Emer] and [PTT].
 - “DRY BATT” is displayed for about 3 sec. then “L” appears when the battery case operation is selected. In this case, the transmit output power is low.
 - “LI-ION” is displayed for about 3 sec. when the Lithium-ion battery operation is selected.

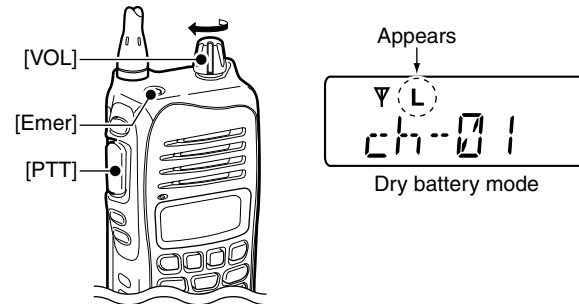

3 BASIC OPERATION

■ Channel selection

Several types of channel selections are available. Methods may differ according to your system set up.

NON-ZONE TYPE:

Push [CH Up] or [CH Down] to select the desired operating channel, in sequence; or, push one of [MR-CH 1] to [MR-CH 4] keys to select a channel directly.

ZONE TYPE:

Push [Zone], then push [CH Up] or [CH Down] to select the desired zone.

AUTOMATIC SCAN TYPE:

Channel setting is not necessary for this type. When turning power ON, the transceiver automatically starts scanning. Scanning stops when receiving a call.

■ Call procedure

When your system employs tone signaling (excluding CTCSS and DTCS), the call procedure may be necessary prior to voice transmission. The tone signaling employed may be a selective calling system which allows you to call specific station(s) only and prevent unwanted stations from contacting you.

- ① Select the desired TX code channel or 5-tone code according to your System Operator's instructions.
 - This may not be necessary depending on programming.
 - Refer to (p. 12) for selection.
- ② Push the call key (assigned to one of the dealer programmable keys: [Emer], [Side1], [Side2], [Side3], [P0], [P1], [P2] and [P3]) or [PTT].
- ③ After transmitting a 5-tone code, the remainder of your communication can be carried out in the normal fashion.

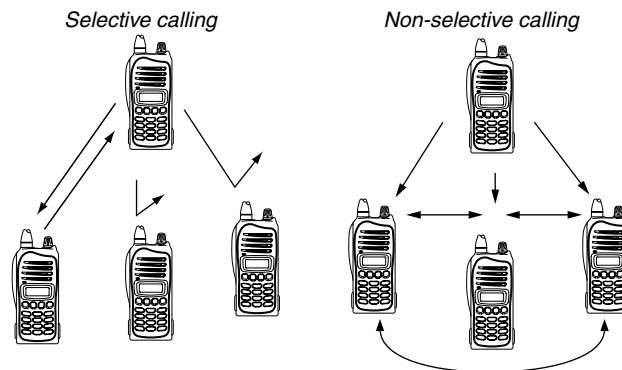

■ Receiving and transmitting

/// **NOTE:** Transmitting without an antenna may damage the transceiver. See (p. 1) for accessory attachments.

Receiving:

- ① Rotate [VOL] to turn the power ON.
- ② Push [CH Up] or [CH Down] to select the conventional system channel, in sequence.
- ③ When receiving a call, adjust the audio output level to a comfortable listening level.

Transmitting:

Wait for the channel to become clear to avoid interference.

- ① Push [Call] when initiating a call from your side.
 - Coded audio may be heard from the transceiver, then “◀” appears.
 - This operation may not be necessary depending on your signaling system. Ask your dealer for details.
- ② While pushing and holding [PTT], speak into the microphone at a normal voice level.
- ③ Release [PTT] to return to receive.

/// **IMPORTANT:** To maximize the readability of your signal;

1. Pause briefly after pushing [PTT].
2. Hold the microphone 5 to 10 cm from your mouth, then speak into the microphone at a normal voice level.

◇ **Transmitting notes**

• **Transmit inhibit function**

The transceiver has several inhibit functions which restrict transmission under the following conditions:

- The channel is in mute condition ('Inaudible' condition; “◀” does not appear.)
- The channel is busy.
- Un-matched (or matched) CTCSS is received. (Depending on the pre-setting.)
- The selected channel is a 'receive only' channel.

• **Time-out timer**

After continuous transmission for the pre-programmed time period, the time-out timer is activated, causing the transceiver to stop transmitting.

• **Penalty timer**

Once the time-out timer is activated, transmission is further inhibited for a period determined by the penalty timer.

• **PTTID call**

The transceiver sends the ID code (5-tone, DTMF or digital ANI) automatically when [PTT] is pushed (beginning of transmission) and released (end of transmission) depends on the setting.

3 BASIC OPERATION

◇ TX code channel selection

If the transceiver has [TX Code CH Select] assigned to it, the indication can be switched between the operating channel number (or name) and TX code channel number (or name). When the TX code channel number (or name) is displayed, [CH Up] or [CH Down] selects the TX code channel.

USING [TX CODE CH SELECT] KEY:

- ① Push [TX Code CH Select]— a TX code channel number (or name) appears.
- ② Push [CH Up] or [CH Down] to select the desired TX code channel.
- ③ After selecting, push [TX Code CH Select] to set.
 - Return to the stand-by mode.
- ④ Push [Call] to transmit the selected TX code.

USING [TX CODE CH UP]/[TX CODE CH DOWN] KEY:

If the transceiver has [TX Code CH Up] or [TX Code CH Down] assignment, the programmed TX code channel can be selected directly when pushed.

◇ TX code number edit

If the transceiver has [TX Code CH Select] or [TX Code Enter] assigned to it, TX code contents can be edited within the allowable digits.

USING [TX CODE CH SELECT] KEY:

- ① Push [TX Code CH Select] to enter the TX code channel selection mode.
 - Select the desired channel with [CH Up] or [CH Down] if necessary.
- ② Push and hold [TX Code CH Select] for 1 sec. to enter the TX code edit mode.
- ③ Push [TX Code CH Select] several times to select the desired digit to be edited.
 - The digit to be edited blinks.
- ④ Push [CH Up], [CH Down] or 10-keypad* to set the desired digit.
- ⑤ Push [TX Code CH Select] to set the digit. The digit to the right will blink automatically.
 - When the 10-keypad* is used for setting, the digit to be edited moves to the right automatically without pushing [TX Code CH Select].
- ⑥ Repeat ④ and ⑤ to input all allowable digits.
- ⑦ After setting the last digit, push [TX Code CH Select] to set the code and return to the stand-by mode.

USING [TX CODE ENTER] KEY:

- ① Select the desired TX code channel. (p. 12)
- ② Push [TX Code Enter] to enter the TX code edit mode.
 - The digit to be edited blinks.
- ③ Push [TX Code Enter] several times to select the desired digit to be edited.
- ④ Push [CH Up], [CH Down] or 10-keypad* to set the desired digit.
- ⑤ Push [TX Code Enter] to set the digit. The digit to the right will blink automatically.
 - When the 10-keypad* is used for setting, the digit to be edited moves to the right automatically without pushing [TX Code Enter].
- ⑥ Repeat ④ and ⑤ to input all allowable digits.
- ⑦ After setting the last digit, push [TX Code Enter] to set the code and return to the stand-by mode.

*10-key versions only

◇ DTMF transmission

If the transceiver has [DTMF Autodial] assigned to it, the automatic DTMF transmission function is available. Up to 8 DTMF channels are available.

TO SELECT A TX CODE:

- ① Push [DTMF Autodial]— a DTMF channel appears.
- ② Push [CH Up] or [CH Down] to select the desired DTMF channel.
- ③ Push [DTMF Autodial] to transmit the DTMF code in the selected DTMF channel.

■ User set mode

User set mode is accessed at power ON and allows you to set seldom-changed settings. In this case you can “customize” the transceiver operation to suit your preferences and operating style.

Entering the user set mode:

- ① While pushing and holding [Side2] and [Side3], rotate [VOL] to turn the power ON. Then, push and hold [P0] for 1 sec. to enter user set mode.
- ② Push [P0] several times to select the appropriate item. Then push [CH Up] or [CH Down] to set the desired level/condition.
 - Available set mode functions are **Backlight**, **Beep**, **Beep Level**, **SQL Level**, **Mic Gain**, **Battery Voltage Signal Moni** and **Lone Worker**.
- ③ Rotate [VOL] to turn the power OFF to exit user set mode.

▨ **NOTE:** User set mode is also available via a programmable function key. Refer to “USER SET MODE KEY.” (p. 8)

■ Stun function

When the specified ID, set as a killer ID, is received, the stun function is activated.

When the killer ID is received, the transceiver switches to the password required condition. Entering of the password via the keypad is necessary to operate the transceiver again in this case. (p. 9)

3 BASIC OPERATION

■ Emergency Call

The emergency call can be performed with [Emergency] (p. 7).

The transceiver will send a 5-tone, DTMF or MDC 1200 emergency signal* one time only or repeatedly on the emergency channel. However, when no emergency channel is specified, the signal is transmitted on the previously selected channel.

If you want to cancel the emergency call, push and hold the key again before transmitting the call.

* Depending on the operating model type.

■ Man Down Emergency Call

This function requires the optional UT-124R MAN DOWN UNIT and can be performed in conventional mode.

The man down emergency call function transmits an emergency call automatically when the transceiver has been left in a horizontal position.

After the emergency call, the transceiver performs transmission and reception alternately with receiving a signal and emitting audio.

When the emergency reset signal is received, the function is cancelled.

 **IMPORTANT:** Set an emergency channel individually, to provide certain emergency call operation is recommended.

■ Scrambler function

The voice scrambler function provides private communication between stations. The optional Rolling or Non-rolling type can be available.

- ① Push [Scrambler] to turn the scrambler function ON.
 - “G” appears.
- ② Push [Scrambler] again to turn the scrambler function OFF.
 - “G” disappears.

■ Priority A channel selection

When one of the following operations is performed, the transceiver selects the Priority A channel automatically.

Priority A is selected when;

- Clear down signal is received/transmitted
 - Set the ‘Move to PrioA CH’ item as ‘Clear down.’
- Turning the power ON
 - The Priority A channel is selected each time the transceiver power is turned ON.
- Status call
 - The Priority A channel is selected when transmitting a status call.

■ MDC 1200 system operation

◇ Receiving an Emergency Call

- ① When an emergency call is received;
- Beeps sound.
 - The calling station alias and “EMG EMG” are displayed alternately.

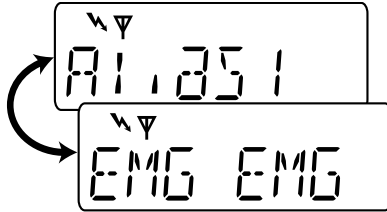

- ② Turn power OFF, change the channel, etc. to stop the beep and display indication.

◇ Receiving a Stun and Revive

The dispatcher can send MDC 1200 system signals that will stun or revive your transceiver. If a Stun command is received that matches your station ID, the transceiver will display “SORRY” and you can not receive or transmit. When a Revive command is received that matches your station ID, normal operation is restored.

■ Caution

Misuse of Lithium-ion batteries may result in the following hazards: smoke, fire, or the battery may rupture. Misuse can also cause damage to the battery or degradation of battery performance.

⚠ **DANGER!** Use and charge only specified Icom battery packs with Icom radios or Icom chargers. Only Icom battery packs are tested and approved for use and charge with Icom radios or Icom chargers. Using third-party or counterfeit battery packs or chargers may cause smoke, fire, or cause the battery to burst.

◇ Battery caution

⚠ **DANGER! DO NOT** hammer or otherwise impact the battery. Do not use the battery if it has been severely impacted or dropped, or if the battery has been subjected to heavy pressure. Battery damage may not be visible on the outside of the case. Even if the surface of the battery does not show cracks or any other damage, the cells inside the battery may rupture or catch fire.

⚠ **DANGER! NEVER** use or leave battery packs in areas with temperatures above +60°C. High temperature buildup in the battery, such as could occur near fires or stoves, inside a sun heated car, or in direct sunlight may cause the battery to rupture or catch fire. Excessive temperatures may also degrade battery performance or shorten battery life.

⚠ **DANGER! DO NOT** expose the battery to rain, snow, seawater, or any other liquids. Never charge or use a wet battery. If the battery gets wet, be sure to wipe it dry before using. The battery is not waterproof.

⚠ **DANGER! NEVER** incinerate used battery packs since internal battery gas may cause them to rupture, or may cause an explosion.

⚠ **DANGER! NEVER** solder the battery terminals or NEVER modify the battery pack. This may cause heat generation, and the battery may rupture, emit smoke or catch fire.

⚠ **DANGER!** Use the battery only with the transceiver for which it is specified. Never use a battery with any other equipment, or for any purpose that is not specified in this instruction manual.

⚠ **DANGER!** If fluid from inside the battery gets in your eyes, blindness can result. Rinse your eyes with clean water, without rubbing them, and see a doctor immediately.

WARNING! Immediately stop using the battery if it emits an abnormal odor, heats up, or is discolored or deformed. If any of these conditions occur, contact your Icom dealer or distributor.

WARNING! Immediately wash, using clean water, any part of the body that comes into contact with fluid from inside the battery.

WARNING! NEVER put the battery in a microwave oven, high-pressure container, or in an induction heating cooker. This could cause a fire, overheating, or cause the battery to rupture.

CAUTION! Always use the battery within the specified temperature range for the transceiver (-25°C to $+55^{\circ}\text{C}$) and the battery itself (-20°C to $+60^{\circ}\text{C}$). Using the battery out of its specified temperature range will reduce the battery's performance and battery life. Please note that the specified temperature range of the battery may exceed that of the transceiver. In such cases, the transceiver may not work properly because it is out of its operating temperature range.

CAUTION! Shorter battery life could occur if the battery is left fully charged, completely discharged, or in an excessive temperature environment (above $+50^{\circ}\text{C}$) for an extended period of time. If the battery must be left unused for a long time, it must be detached from the radio after discharging. You may use the battery until the remaining capacity is about half, then keep it safely in a cool dry place with the temperature range as below:

-20°C to $+50^{\circ}\text{C}$ (within a month)

-20°C to $+35^{\circ}\text{C}$ (within three months)

-20°C to $+20^{\circ}\text{C}$ (within a year)

◇ Charging caution

⚠ **DANGER! NEVER** charge the battery pack in areas with extremely high temperatures, such as near fires or stoves, inside a sun heated car, or in direct sunlight. In such environments, the safety/protection circuit in the battery will activate, causing the battery to stop charging.

WARNING! NEVER charge or leave the battery in the battery charger beyond the specified time for charging. If the battery is not completely charged by the specified time, stop charging and remove the battery from the battery charger. Continuing to charge the battery beyond the specified time limit may cause a fire, overheating, or the battery may rupture.

WARNING! NEVER insert the transceiver (battery attached to the transceiver) into the charger if it is wet or soiled. This could corrode the battery charger terminals or damage the charger. The chargers are not waterproof.

CAUTION! NEVER charge the battery outside of the specified temperature range: BC-160 (0°C to $+40^{\circ}\text{C}$). Icom recommends charging the battery at $+20^{\circ}\text{C}$. The battery may heat up or rupture if charged out of the specified temperature range. Additionally, battery performance or battery life may be reduced.

4 BATTERY CHARGING

■ Optional battery chargers

◇ Rapid charging with the BC-160

The optional BC-160 provides rapid charging of optional Li-Ion battery packs.

The following items are additionally required:

- An AC adapter (may be supplied with BC-160 depending on version) or the DC power cable (OPC-515L/CP-17L) is additionally required.

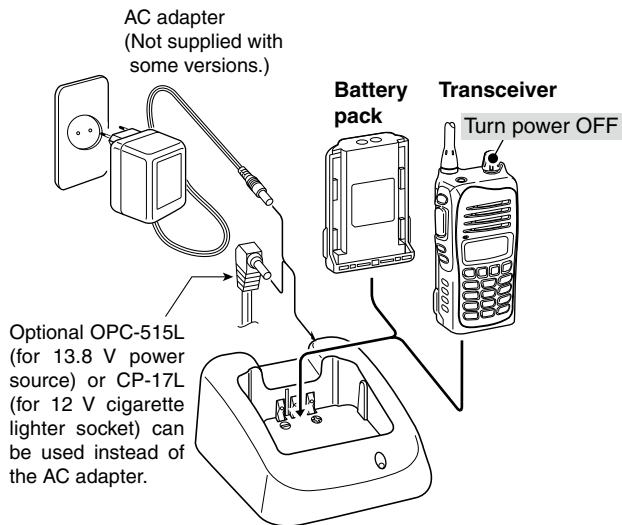

*See the instruction manual for details of the charger LED indication, operation, etc.

◇ Regular charging with the BC-171

The optional BC-171 provides regular charging of the Li-Ion battery pack. Charging period: Approx. 10 hours (with BP-232N)

The following items are additionally required:

- An AC adapter (may be supplied with BC-171 depending on version) or the DC power cable (OPC-515L/CP-17L).

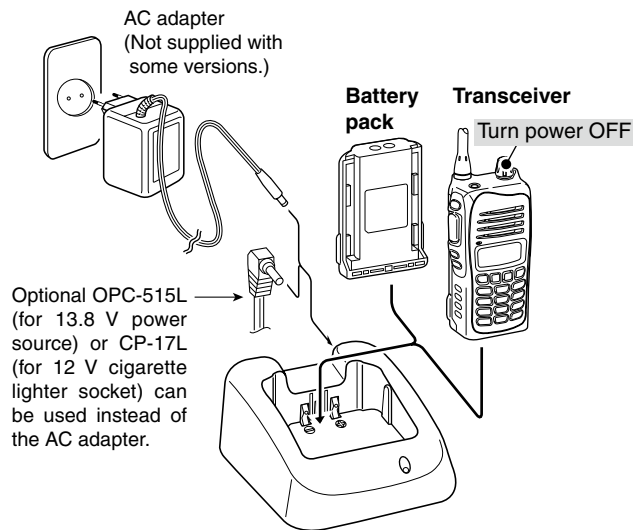

*See the instruction manual for details of the charger LED indication, operation, etc.

◇ **AD-106 installation**

The AD-106 CHARGER ADAPTER must be installed into the BC-119N or BC-121N before battery charging.

- Connect the AD-106 CHARGER ADAPTER and the BC-119N/BC-121N as below, then install the AD-106 into the holder space of the BC-119N or BC-121N with the supplied screws.

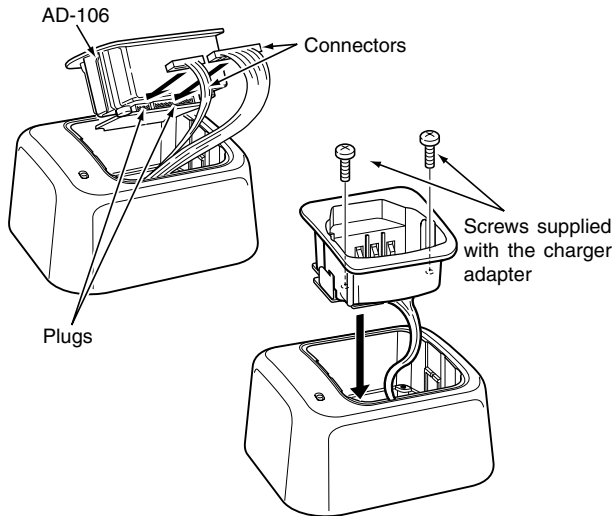

* This illustration is described with the BC-119N.

◇ **Rapid charging with the BC-119N+AD-106**

The optional BC-119N provides rapid charging of battery packs.

The following items are additionally required.

- AD-106 charger adapter
- An AC adapter (may be supplied with BC-119N depending on version) or the DC power cable (OPC-515L/CP-17L).

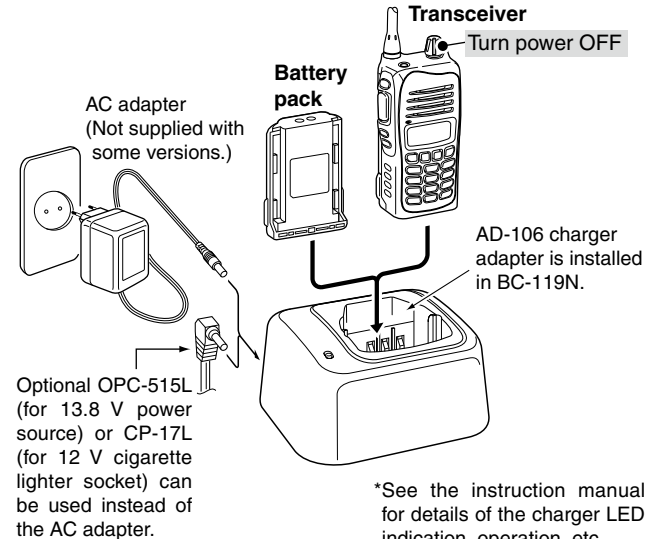

*See the instruction manual for details of the charger LED indication, operation, etc.

4 BATTERY CHARGING

◇ Rapid charging with the BC-121N+AD-106

The optional BC-121N allows up to 6 battery packs to be charged simultaneously.

The following items are additionally required.

- Six AD-106 charger adapters
- An AC adapter (BC-157) or the DC power cable (OPC-656)

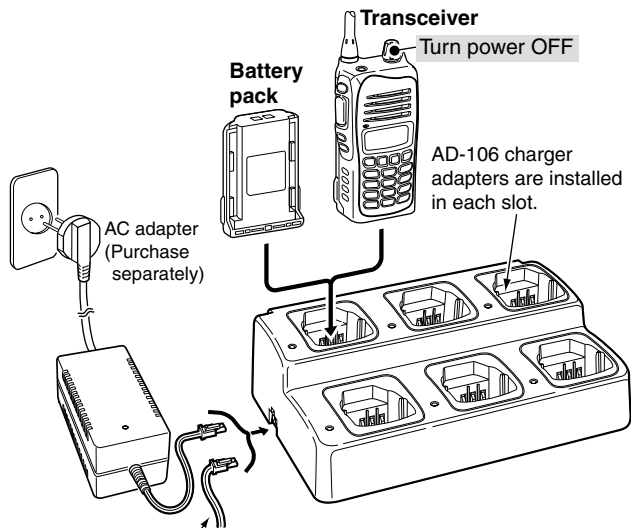

*See the instruction manual for details of the charger LED indication, operation, etc.

IMPORTANT: Battery charging caution

Ensure the guide lobes on the battery pack are correctly aligned with the guide rails inside the charger adapter. (This illustration is described with the BC-160.)

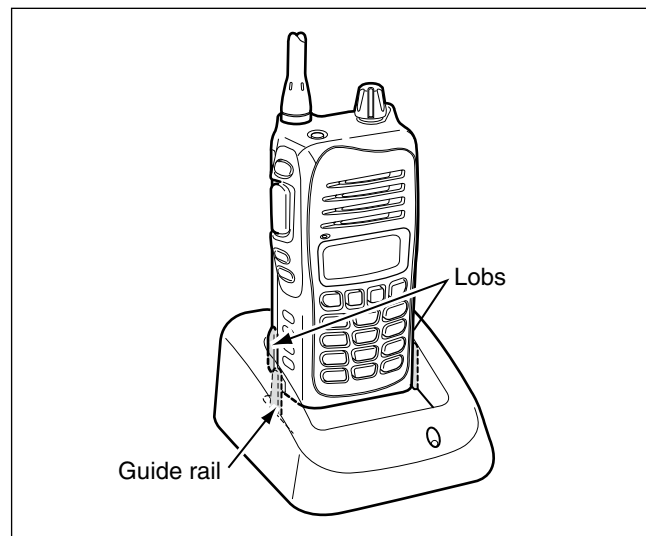

■ Optional battery case (BP-240)

When using the optional battery case, install 6 × AAA (LR03) size alkaline batteries as illustrated at right.

- ① Unhook the battery cover release hook (①), and open the cover in the direction of the arrow (②). (Fig.1)
- ② Then, install 6 × AAA (LR03) size alkaline batteries. (Fig.2)
 - Install the alkaline batteries only.
 - Be sure to observe the correct polarity.
 - Do not pin the ribbon under the batteries.
- ③ Fit the cover in the direction of the arrow (③), then close (④). And hook the battery cover release hook until it makes a 'click' sound (⑤). (Fig.3)

CAUTION:

- When installing batteries, make sure they are all the same brand, type and capacity. Also, do not mix new and old batteries together.
- Keep battery contacts clean. It's a good idea to clean battery terminals once a week.
- Never incinerate used battery cells since internal battery gas may cause them to rupture.
- Never expose a detached battery case to water. If the battery case gets wet, be sure to wipe it dry before using it.

NOTE: When the optional battery case is attached, the battery type must be selected to "DRY BATT" when turning the transceiver ON. (p. 9)

Fig.1

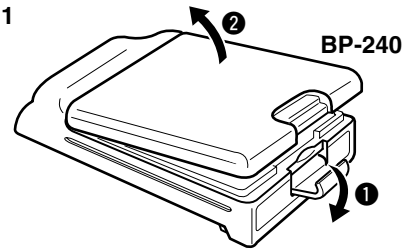

Fig.2

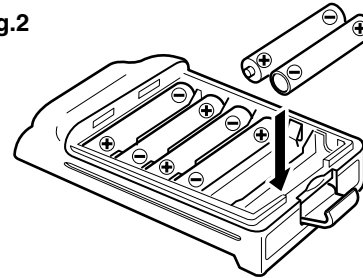
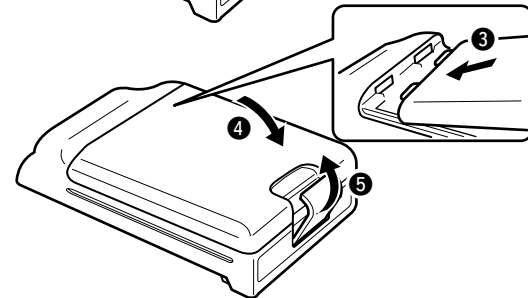

Fig.3



6

OPTIONAL SWIVEL BELT CLIP

■ MB-93 contents

	Qty.
① Belt clip	1
② Base clip	1

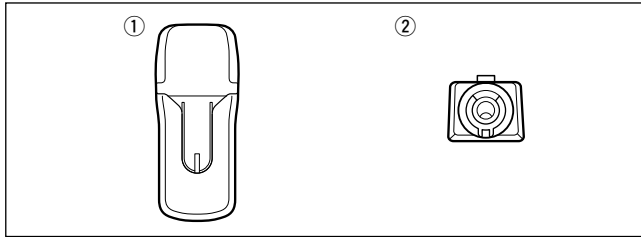

■ Attaching

- ① Release the battery pack if it is attached. (p. 2)
- ② Slide the base clip in the direction of the arrow until the base clip is locked and makes a 'click' sound.

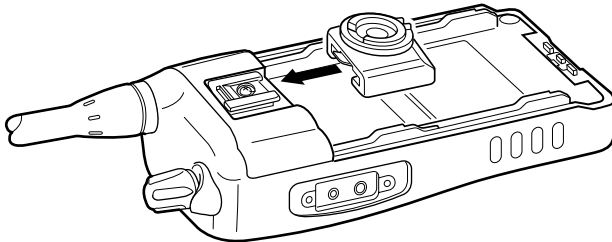

- ③ Clip the belt clip to a part of your belt. And insert the transceiver into the belt clip until the base clip inserted fully into the groove.

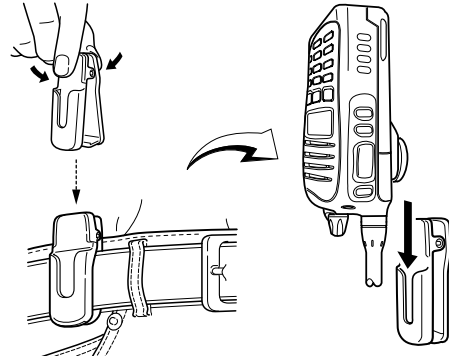

- ④ Once the transceiver is locked in place, it swivels as illustrated below.

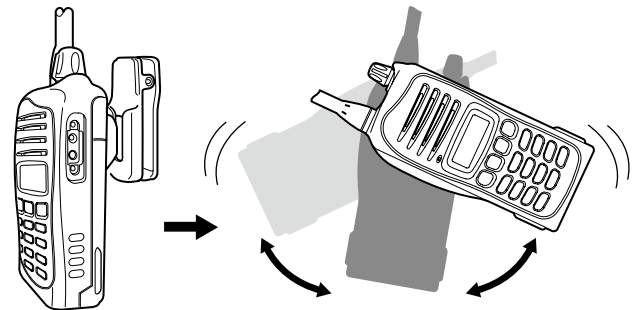

Once the transceiver is locked in place, it will swivel 360 degrees.

■ Detaching

- ① Turn the transceiver upside down in the direction of the arrow and pull out from the belt clip.

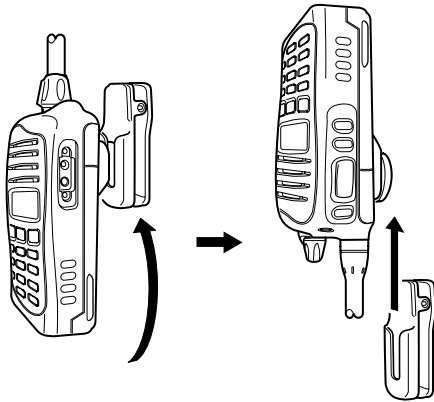

- ② Release the battery pack if it is attached. (p. 2)
- ③ Pinch the clip (①), and slide the base clip in the direction of the arrow (②).

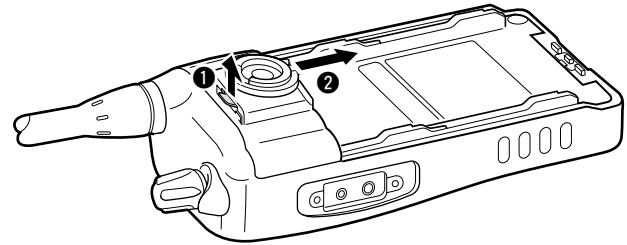

CAUTION!
HOLD THE TRANSCEIVER TIGHTLY, WHEN HANGING OR DETACHING THE TRANSCEIVER FROM THE BELT CLIP.

Otherwise the transceiver may not be attached to the holder or swivel properly if the transceiver is accidentally dropped and the base clip is scratched or damaged.

◇ BATTERY PACKS

Battery pack	Voltage	Capacity	Battery life*1
BP-230N	7.4 V	980 mAh	7.35 hrs.
BP-232N	7.4 V	2000 mAh	15.5 hrs.
BP-240	Battery case for AAA (LR03) × A6 alkaline		—*2

*1 When the power save function is turned ON, and the operating periods are calculated under the following conditions;
TX : RX : standby = 5 : 5 : 90

*2 Operating period depends on the alkaline cells used.

◇ CHARGERS

- **BC-119N** DESKTOP CHARGER + **AD-106** CHARGER ADAPTER + **BC-145** AC ADAPTER

For rapid charging of battery packs. An AC adapter is supplied with the charger depending on versions.

Charging time: approx. 3 hours when BP-232N is attached.

- **BC-121N** MULTI-CHARGER + **AD-106** CHARGER ADAPTER (6 pcs.) + **BC-157** AC ADAPTER

For rapid charging of up to 6 battery packs (six AD-106's are required) simultaneously. An AC adapter should be purchased separately.

Charging time: approx. 3 hours when BP-232N is attached.

- **BC-160** DESKTOP CHARGER + **BC-145** AC ADAPTER

For rapid charging of battery packs. An AC adapter is supplied with the charger depending on versions.

Charging time: approx. 3 hours when BP-232N is attached.

- **BC-171** DESKTOP CHARGER + **BC-147** AC ADAPTER

For regular charging of battery packs. We recommend that the BP-230N charging. An AC adapter is supplied with the charger depending on versions.

Charging time: approx. 10 hours when BP-232N is attached. approx. 4 hours when BP-230N is attached.

◇ DC CABLES

- **CP-17L** CIGARETTE LIGHTER CABLE

Allows charging of the battery pack through a 12 V cigarette lighter socket. (For BC-119N)

- **OPC-515L/OPC-656** DC POWER CABLES

Allows charging of the battery pack using a 13.8 V power source instead of the AC adapter.

OPC-515L: For BC-119N

OPC-656 : For BC-121N

◇ BELT CLIPS

- **MB-93** SWIVEL BELT CLIP

- **MB-94** BELT CLIP

Exclusive alligator-type belt clip.

- **MB-96N/96F** LEATHER BELT HANGER

◇ **OPTIONAL UNITS**

- **UT-108R** DTMF DECODER UNIT
Provides pager and code squelch capabilities.
- **UT-109R /UT-110R*** VOICE SCRAMBLER UNITS
Non-rolling type (UT-109R)/Rolling type (UT-110R)* voice scrambler unit provides higher communication security.
*You can use the UT-110R as Non-rolling type.
- **UT-124R** MAN DOWN UNIT
Provides measure of safety when working in a hazardous environment, etc.

◇ **OTHER OPTIONS**

- **SP-13** EARPHONE
Provides clear receive audio in noisy environment.
- **HM-153L** EARPHONE-MICROPHONE
Durable earphone-microphone with revolving clip.
- **HM-158L/HM-159L** SPEAKER-MICROPHONE
Combination speaker-microphone that provides convenient operation while hanging the transceiver from your belt.
HM-158L : Compact and durable body with screw-type connector.
HM-159L : Full size durable speaker microphone.
- **HS-94/HS-95/HS-97** HEADSET + **VS-1L** VOX/PTT CASE
HS-94 : Ear-hook type
HS-95 : Neck-arm type
HS-97 : Throat microphone
VS-1L : VOX/PTT switch box for hands-free operation, etc.

- **FA-SC25V/FA-SC55V/FA-SC25U/FA-SC57U** ANTENNAS
FA-SC25V: 136–150 MHz FA-SC55V: 150–174 MHz
FA-SC25U: 400–430 MHz FA-SC57U: 430–470 MHz
- **FA-SC56VS/FA-SC57VS/FA-SC73US** STUBBY ANTENNAS
FA-SC56VS: 150–162 MHz FA-SC57VS: 160–174 MHz
FA-SC73US: 450–490 MHz
- **FA-SC61VC/FA-SC61UC** CUT ANTENNAS
FA-SC61VC: 136–174 MHz FA-SC61UC: 380–520 MHz

Some options may not be available in some countries. Ask your dealer for details.

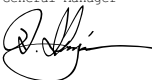
	DECLARATION OF CONFORMITY
<p>We Icom Inc. Japan 1-1-32, Kamiminami, Hirano-ku Osaka 547-0003, Japan</p> <p>Declare on our sole responsibility that this equipment complies with the essential requirements of the Radio and Telecommunications Terminal Equipment Directive, 1999/5/EC, and that any applicable Essential Test Suite measurements have been performed.</p> <p>Kind of equipment: VHF PMR TRANSCEIVER</p> <p>Type-designation: IC-F3022T/F3022S</p> <p>Version (where applicable): This compliance is based on conformity with the following harmonised standards, specifications or documents:</p> <ul style="list-style-type: none"> i) EN 60950-1 (2001) ii) EN 301 489-1 V1.4.1 (August 2002) iii) EN 301 489-5 V1.3.1 (August 2002) iv) EN 300 086-2 (March 2001) v) EN 300 219-2 (March 2001) vi) EN 300 113-2 (April 2002) vii) _____ 	<p style="text-align: center;">CE0168 ⓘ</p> <p><u>Düsseldorf 3rd Mar. 2006</u> Place and date of issue</p> <p>Icom (Europe) GmbH Himmelgeisterstraße 100 D-40225 Düsseldorf Authorized representative name</p> <p>H. Ikegami General Manager</p>  <p>Signature</p> <p style="text-align: center;">Icom Inc.</p>

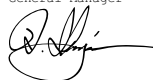
	DECLARATION OF CONFORMITY
<p>We Icom Inc. Japan 1-1-32, Kamiminami, Hirano-ku Osaka 547-0003, Japan</p> <p>Declare on our sole responsibility that this equipment complies with the essential requirements of the Radio and Telecommunications Terminal Equipment Directive, 1999/5/EC, and that any applicable Essential Test Suite measurements have been performed.</p> <p>Kind of equipment: UHF PMR TRANSCEIVER</p> <p>Type-designation: IC-F4022T/F4022S 400-470 MHz 6.25 kHz/12.5 kHz/ 20 kHz/25 kHz</p> <p>Version (where applicable): This compliance is based on conformity with the following harmonised standards, specifications or documents:</p> <ul style="list-style-type: none"> i) EN 60950-1 (2001) ii) EN 301 489-1 V1.4.1 (August 2002) iii) EN 301 489-5 V1.3.1 (August 2002) iv) EN 300 086-2 (March 2001) v) EN 300 219-2 (March 2001) vi) EN 300 113-2 (April 2002) vii) EN 301 166-2 V1.1.1 (December 2001) 	<p style="text-align: center;">CE0168 ⓘ</p> <p><u>Düsseldorf 21th Apr. 2006</u> Place and date of issue</p> <p>Icom (Europe) GmbH Himmelgeisterstraße 100 D-40225 Düsseldorf Authorized representative name</p> <p>H. Ikegami General Manager</p>  <p>Signature</p> <p style="text-align: center;">Icom Inc.</p>

CE CE versions of the IC-F3022T/S and the IC-F4022T/S which display the “CE” symbol on the serial number seal, comply with the essential requirements of the European Radio and Telecommunication Terminal Directive 1999/5/EC.

! This warning symbol indicates that this equipment operates in non-harmonised frequency bands and/or may be subject to licensing conditions in the country of use. Be sure to check that you have the correct version of this radio or the correct programming of this radio, to comply with national licensing requirement.

Count on us!

< Intended Country of Use >

- GER FRA ESP SWE
 AUT NED POR DEN
 GBR BEL ITA FIN
 IRL LUX GRE SUI
 NOR

A-6507D-1EU-⑤
Printed in Japan
© 2006–2008 Icom Inc.

Printed on recycled paper with soy ink.

Icom Inc.

1-1-32 Kamiminami, Hirano-ku, Osaka 547-0003, Japan